

Schools

Covid-19 Toolkit

Covid-19 Guidance Posters

Use this guide to print and install Covid-19 messaging in and around school grounds.

Posters to print from this toolkit:



Display at pick-up / drop-off areas.

Display at entrances to areas where parents are not allowed.

Display with hand sanitiser.

Display in quiet areas - separate to critical messaging.

Wayfinding arrows.

How to use this toolkit:

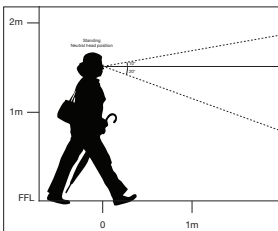
Step 1: Printing the posters	Step 2: Identifying the best locations to install	Step 3: Install the posters to weather and last	Step 4: Installation best-practice
<ul style="list-style-type: none"> • Print at 100% on A4 paper, or 200% on A3 paper. • Print all posters using a colour printer. • Print all posters on the same paper stock for consistency. <p>Tip: Only print the posters you need to use, in order to reduce waste.</p>	<ul style="list-style-type: none"> • Place posters where they will have most impact. <p>For example:</p> <ul style="list-style-type: none"> • Place public bench messaging on/by the bench, not at the entrance to the park. <p>Tip: Don't bombard people with too many messages at once.</p>	<ul style="list-style-type: none"> • Install in sheltered areas where possible. • Install on the inside of glass where possible. • Laminate posters if possible for outdoor areas. • Install straight and cleanly with strong clear or black tape. <p>Tip: Reduce lamination costs and waste by only laminating posters that could get rained on.</p>	<ul style="list-style-type: none"> • Install at eye-level. 1.4m is the optimum height.  <p>Tip: Remove other unimportant posters that distract from Covid-19 messaging.</p>

Guide

Recreatable notices

Don't have a printer?

Use this guide to create your own posters. You will need two toilet paper rolls, a pencil, a black marker, paper and a pair of scissors.

Create your shapes:

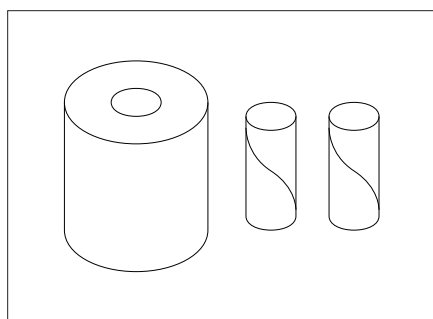

You will need two empty toilet rolls

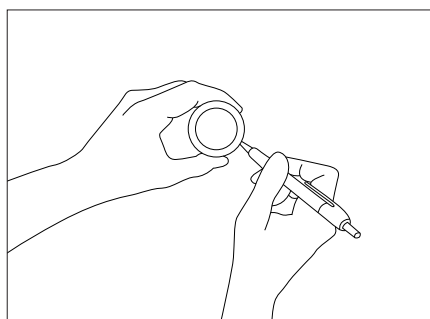

Use one roll to draw circles

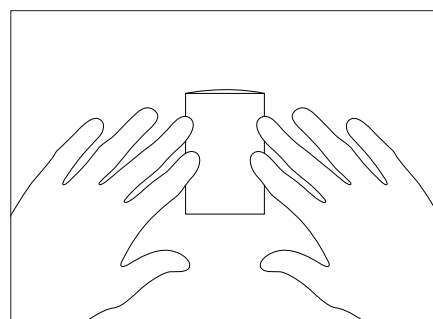

Fold the second roll in half

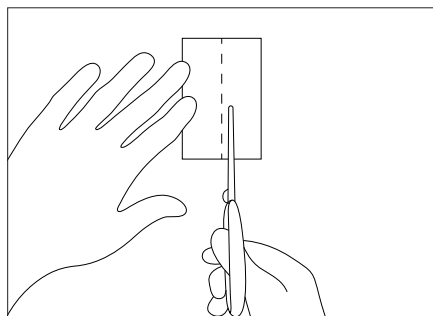

Cut along one of the fold lines

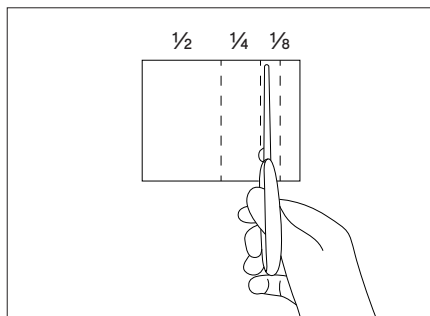

Open and cut into $\frac{1}{2}$, $\frac{1}{4}$ and two $\frac{1}{8}$'s

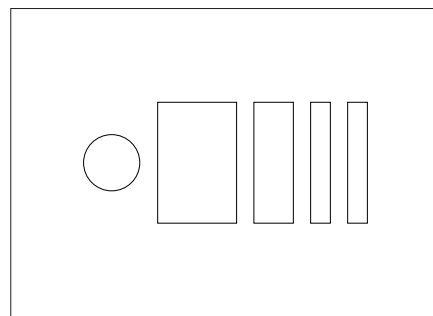

Use these shapes to create pictograms

How to draw your own posters:

1. Outline and combine shapes with pencil.

Leave space for large message

Leave space for small message

2. Fill in the shapes with a black marker.

3. Use the rectangle to align the height of letters.

Pick up kids,
not germs.

Please keep your distance from
other parents and guardians.

4. Go over the letters to make letters bolder.

Pick up kids,
not germs.

Please keep your distance from
other parents and guardians.

Pick up kids, not germs.

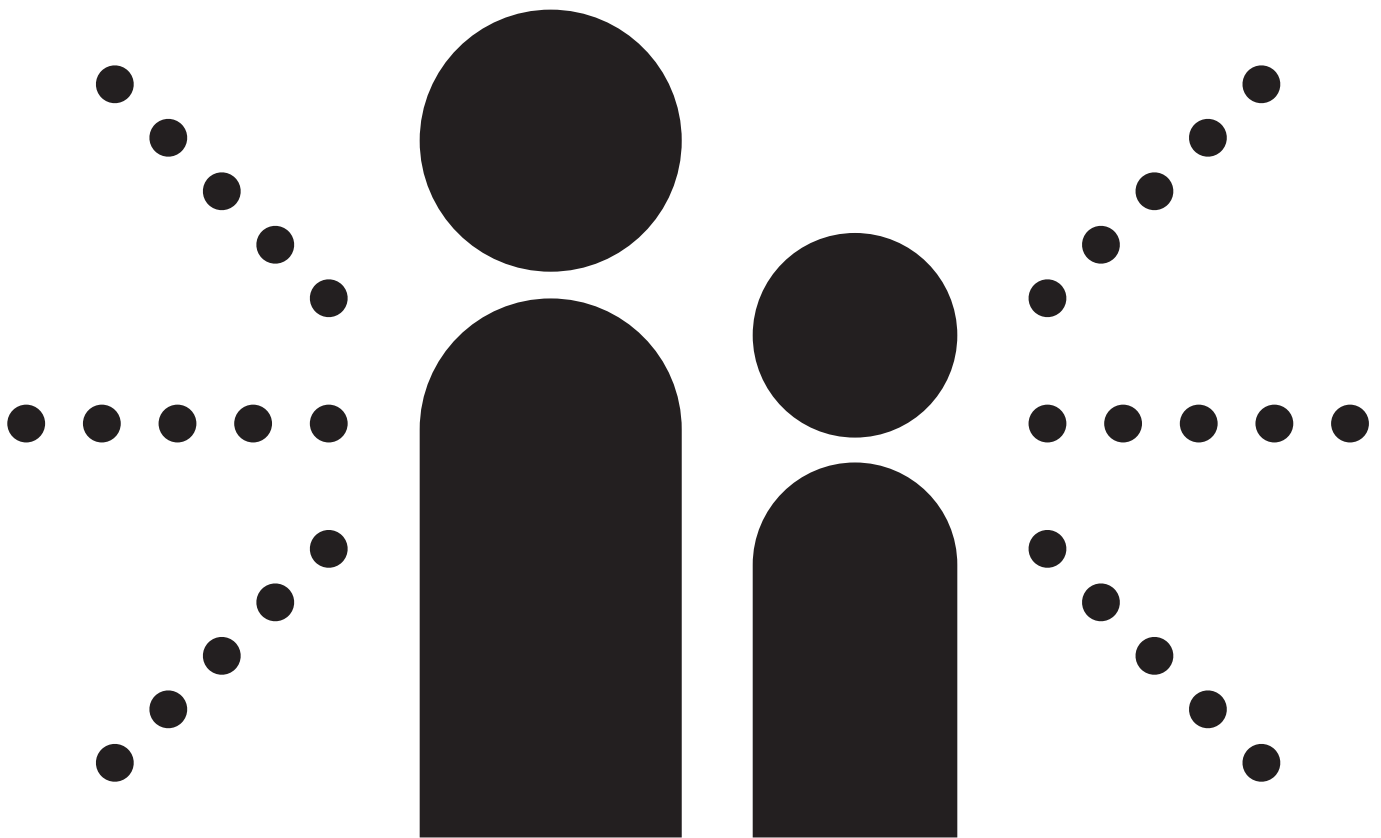

Please keep your distance from
other parents and guardians.

Those hands! Wash 'em!

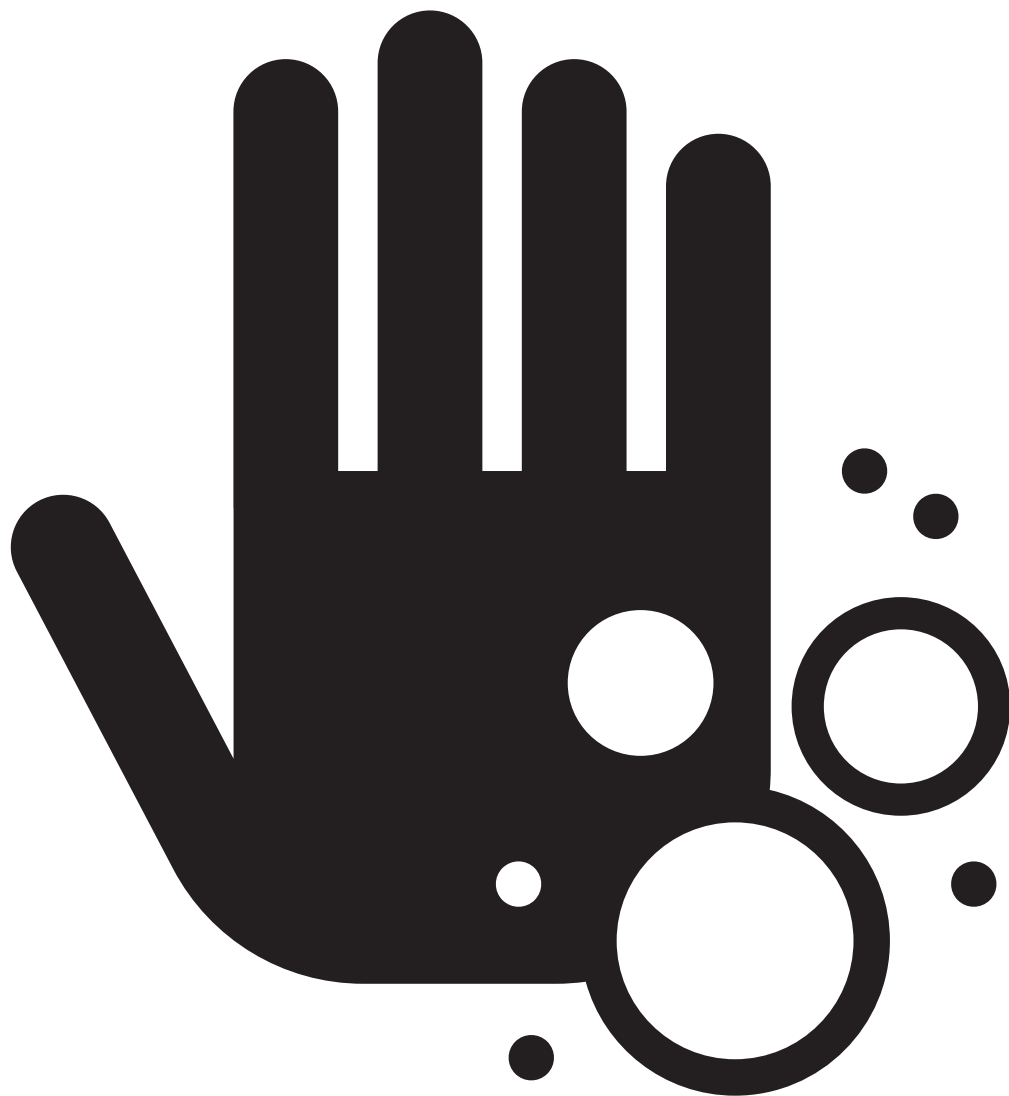

Remember that all hands, big or little,
need to be washed when you get home.

Feeling unsure?

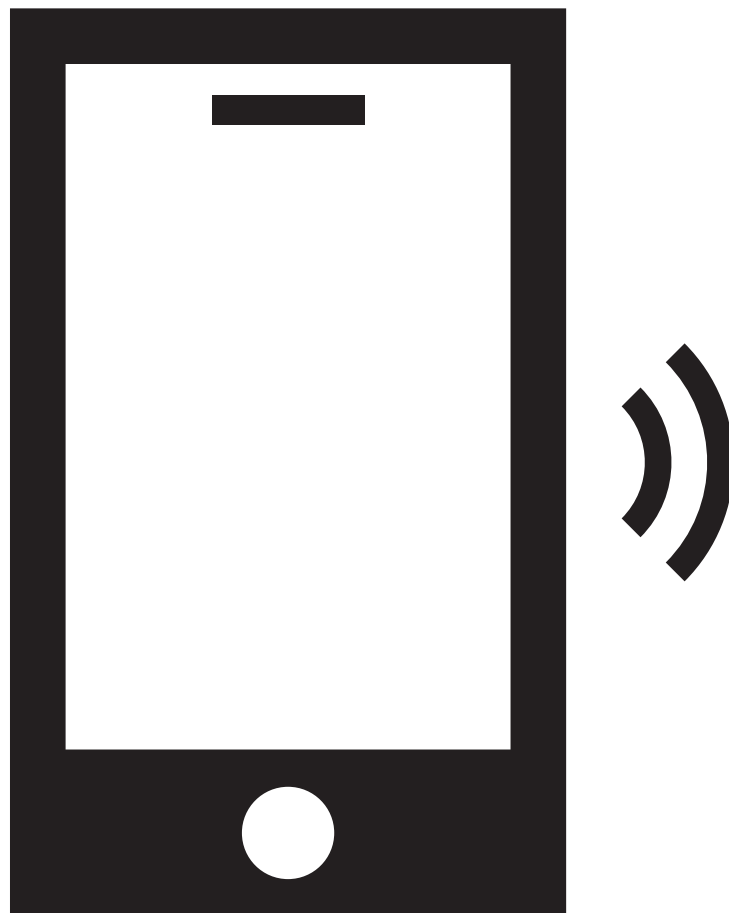

Contact us for guidance.

Sick days are okay.



If your child or anyone in your household is showing symptoms, please stay home.

This is the kids-zone.

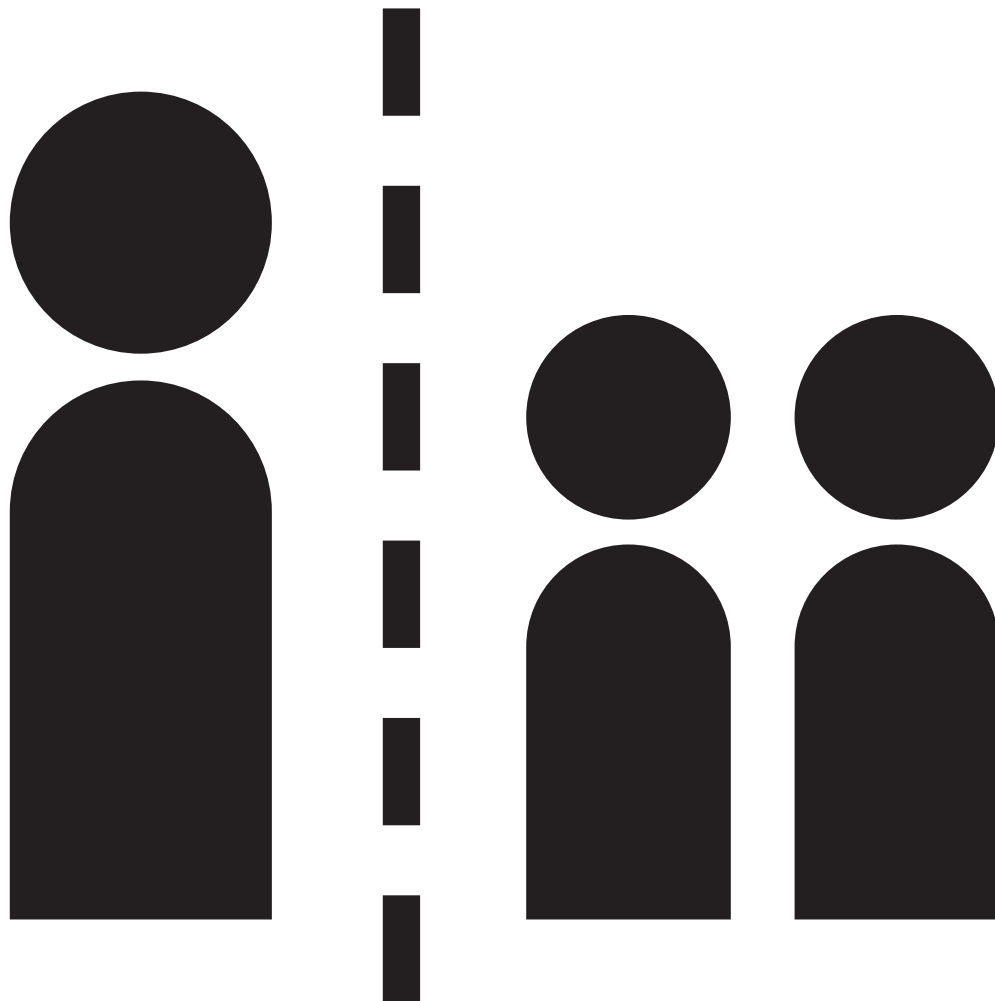

For everyone's safety, parents and guardians aren't allowed past this point.

Hand sanitiser

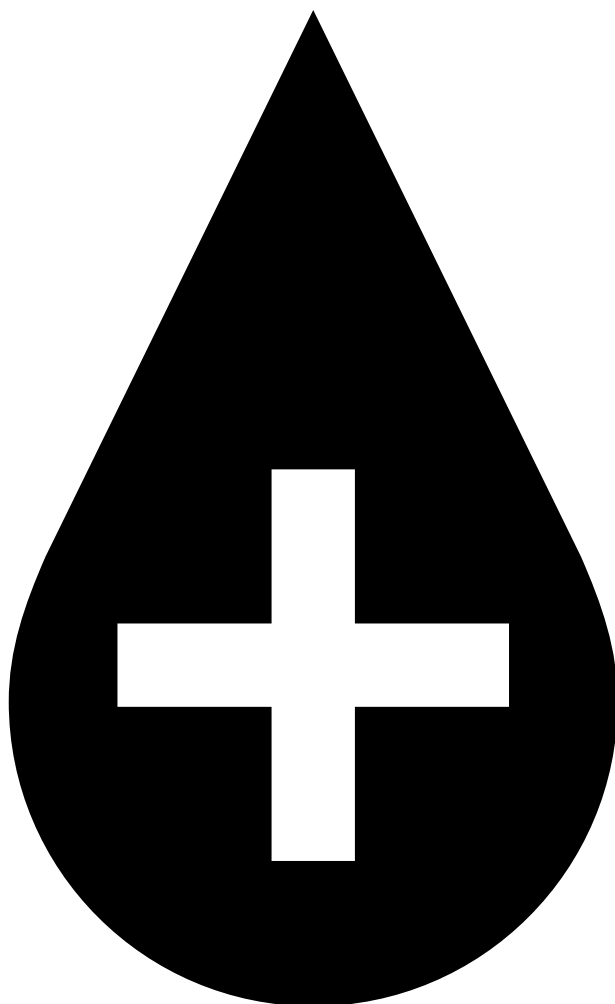

Everyone must sanitise their hands
before entering. Thank you!

**Be brave.
Be kind.**

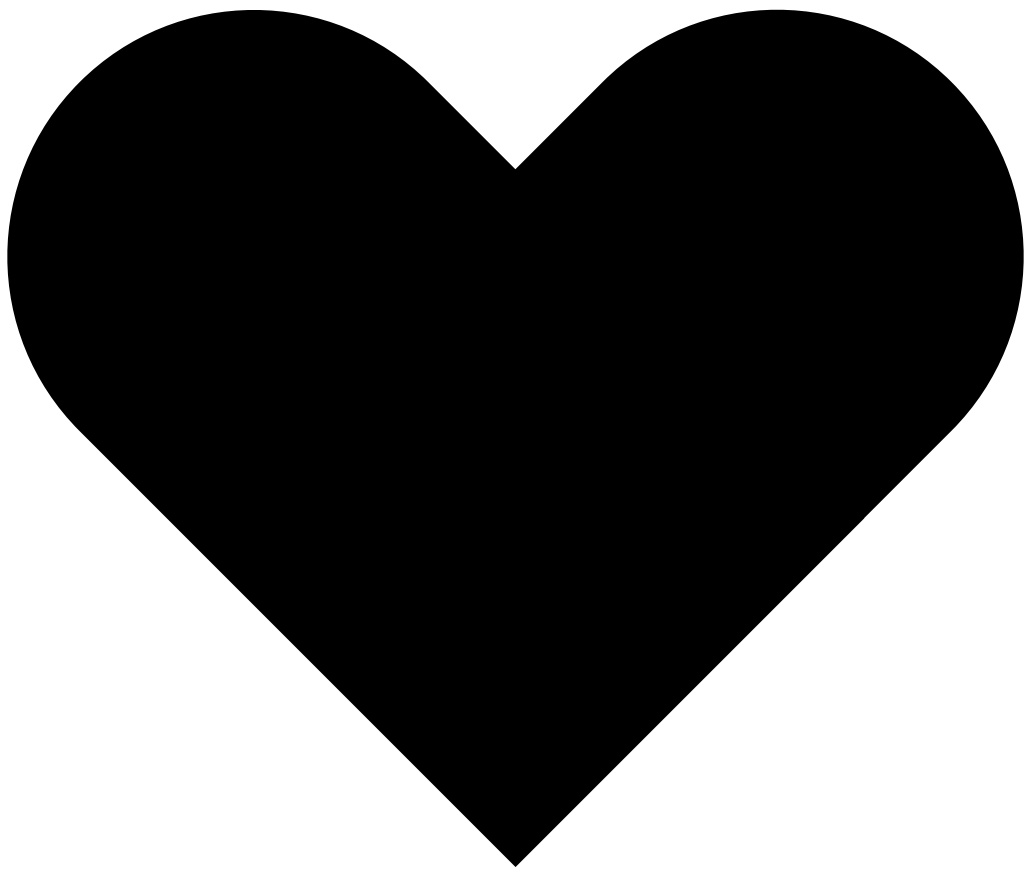

And please reach out if you need help.

this way

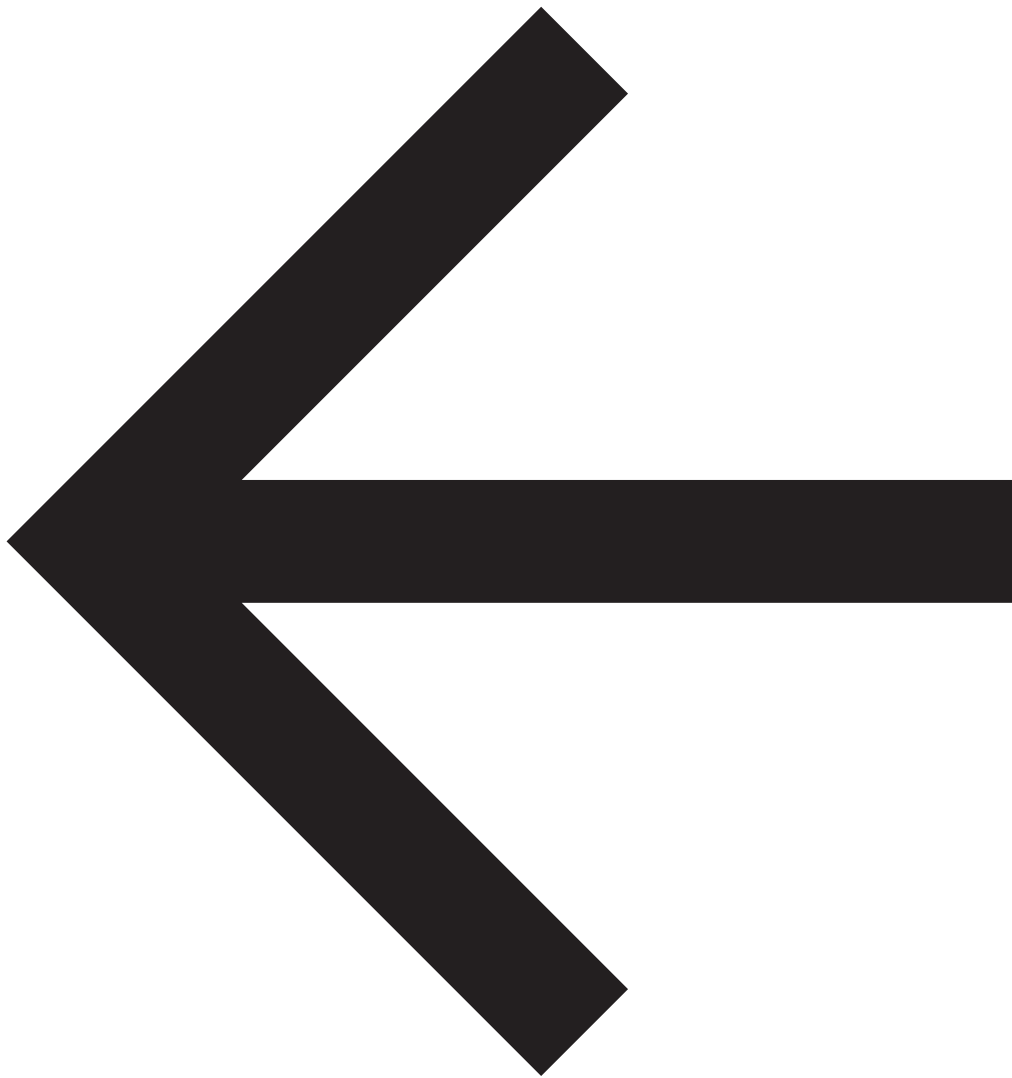

Pick-up Drop-off

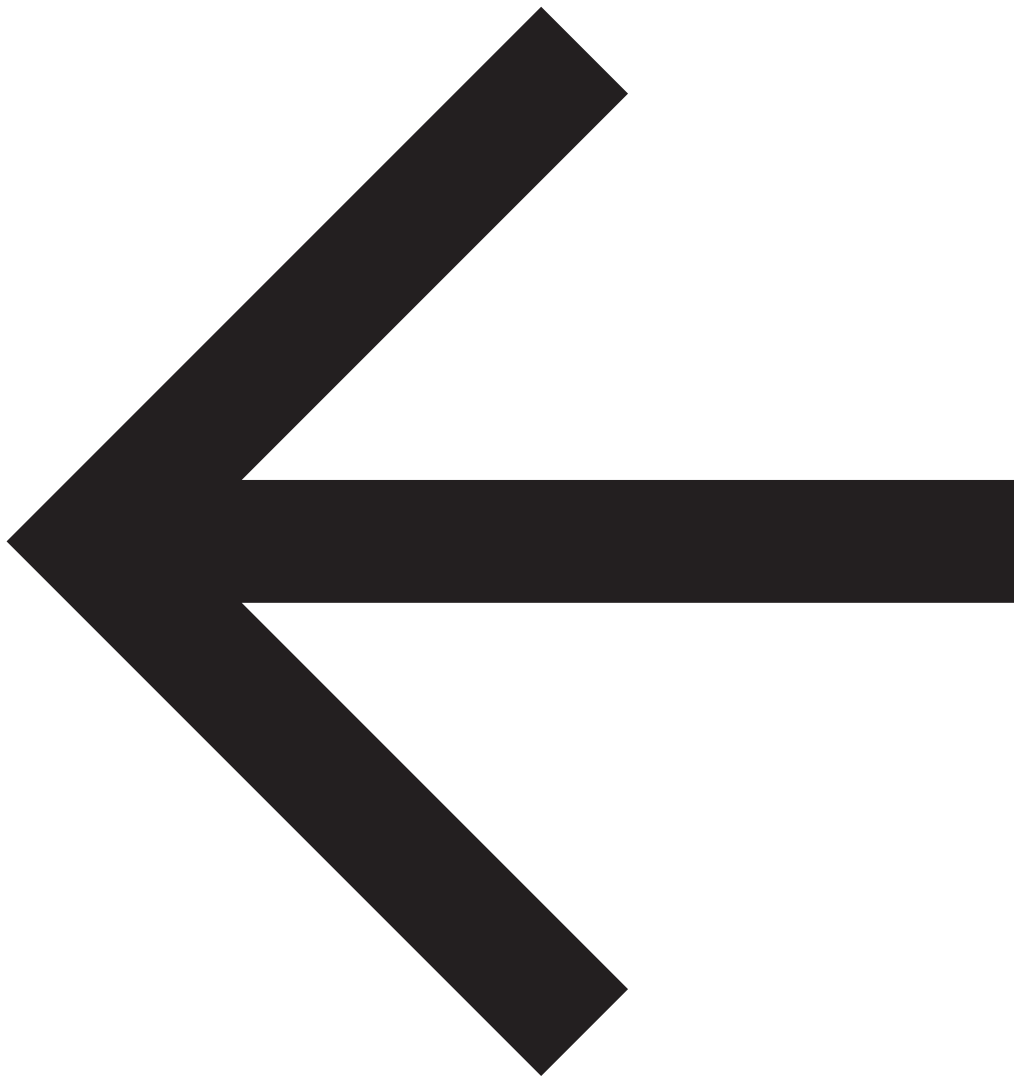

this way

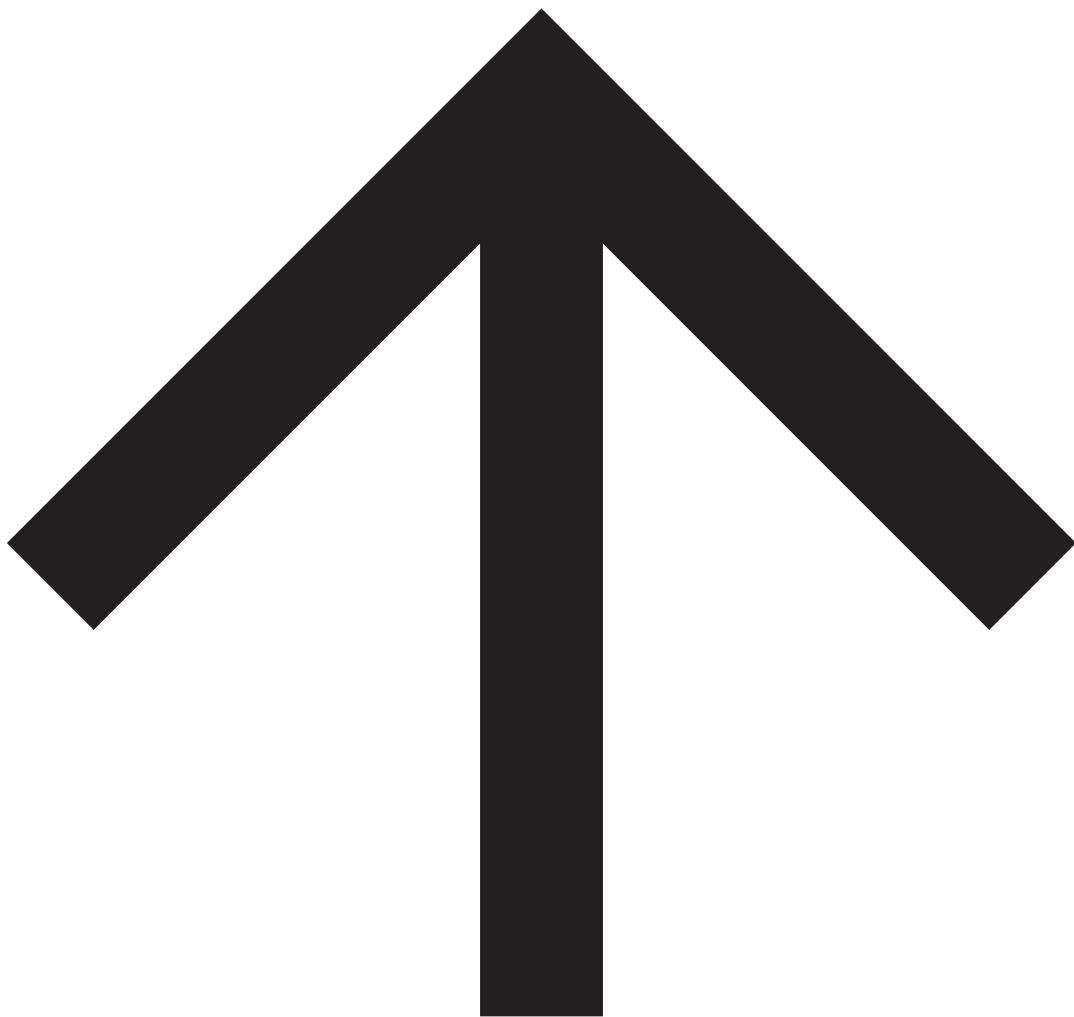

Pick-up Drop-off

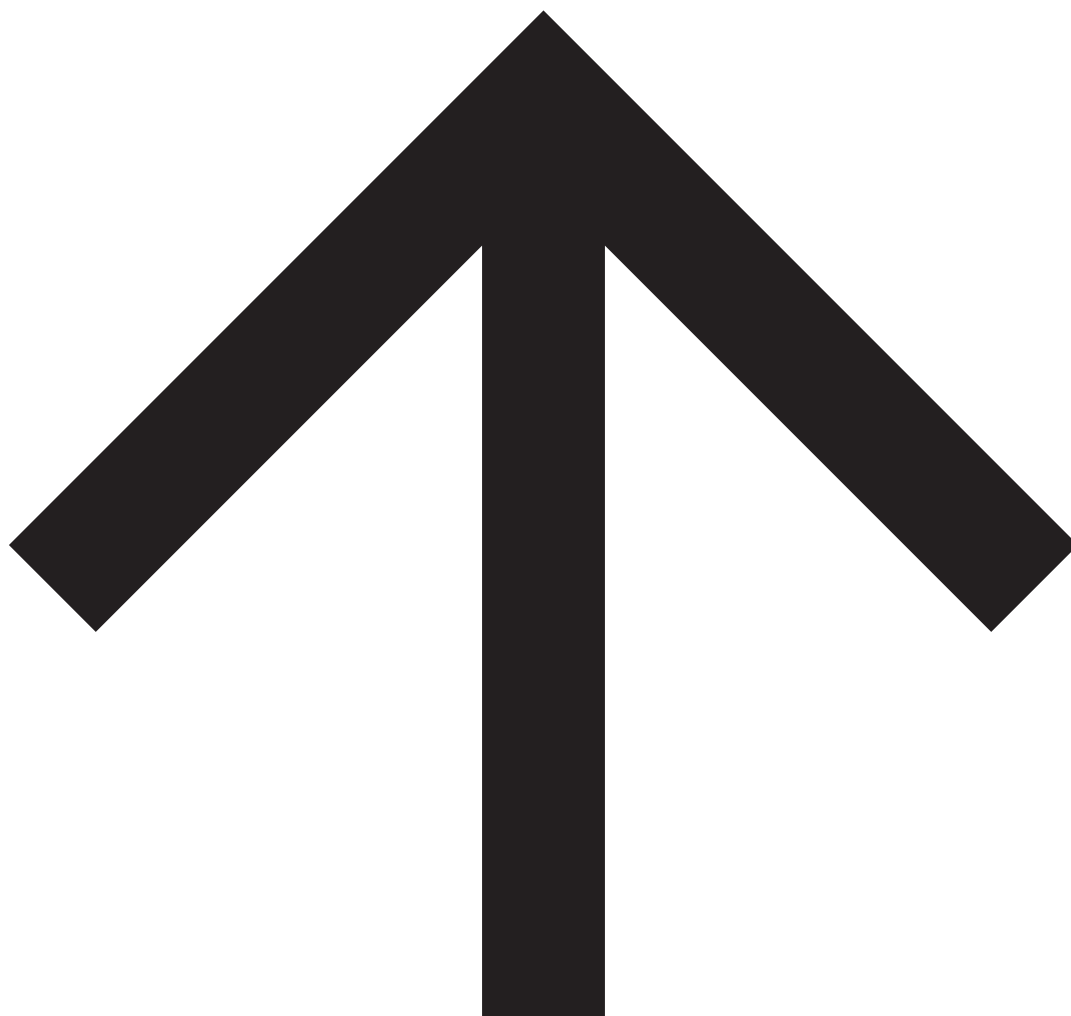

this way

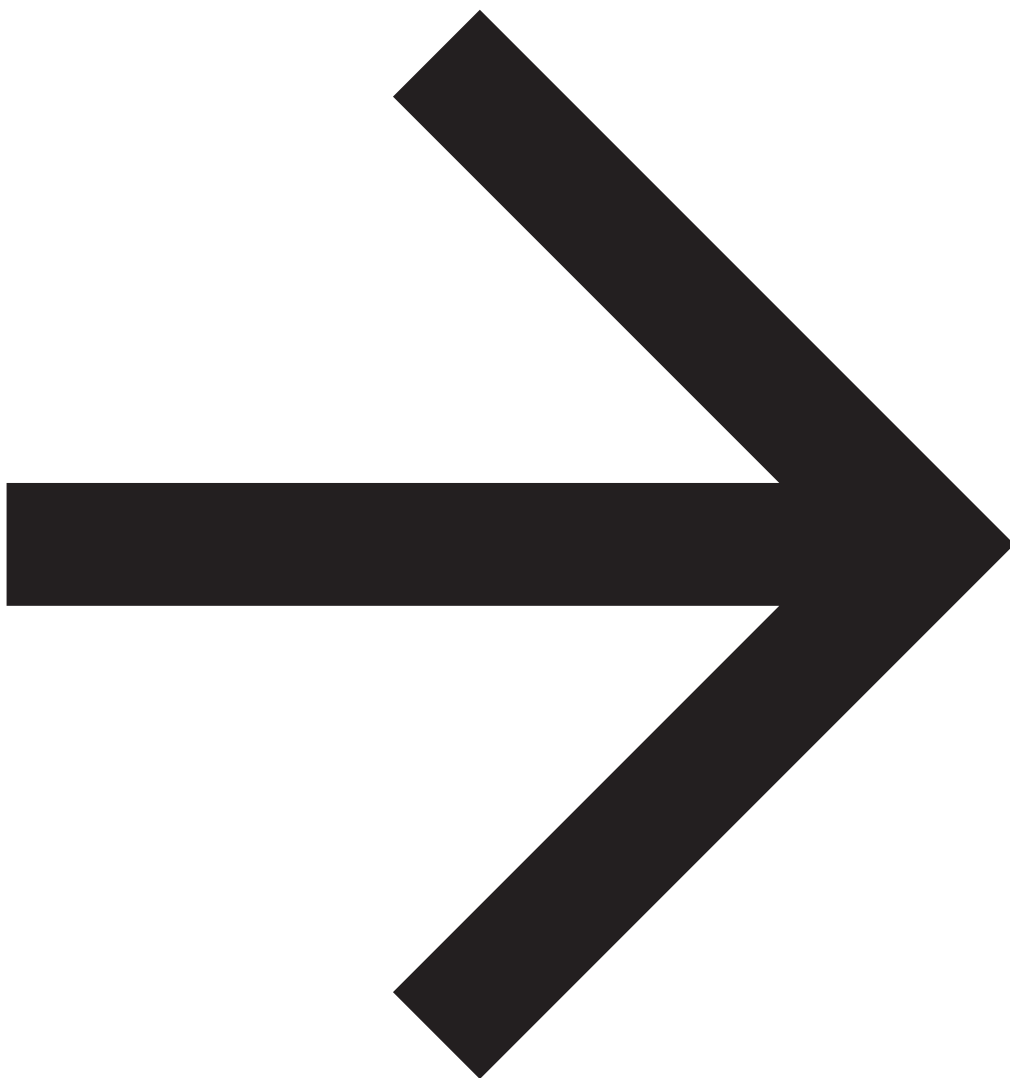

Pick-up Drop-off

