

Health

Covid-19 Toolkit

Covid-19 Guidance Posters

Use this guide to print and install Covid-19 messaging in essential health services and businesses.

Posters to print from this toolkit:

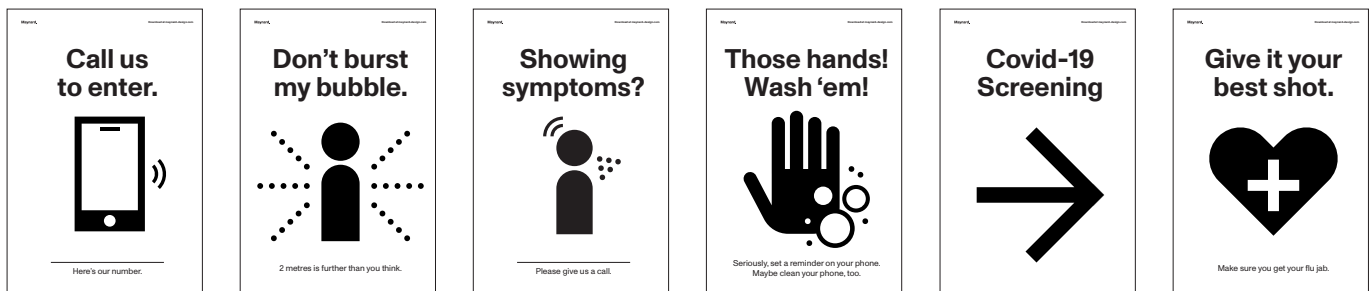

Display clearly at entrance.

Display at entrance and congested areas.

Display clearly at entrance.

Display at exit.

Arrow + caption options for directing patients.

Display in staff facing areas to encourage flu vaccines.

How to use this toolkit:

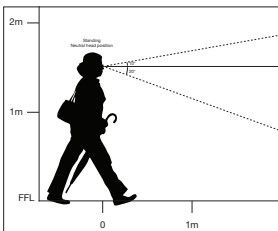
<p>Step 1: Printing the posters</p> <ul style="list-style-type: none"> Print at 100% on A4 paper, or 200% on A3 paper. Print all posters on fluro yellow paper for best effect. Print all posters on the same paper stock for consistency. <p>Tip: Check your local stationery store for fluro paper delivery.</p>	<p>Step 2: Identifying the best locations to install</p> <ul style="list-style-type: none"> Place posters where they will have most impact. <p>For example:</p> <ul style="list-style-type: none"> Place public bench messaging on/by the bench, not at the entrance to the park. <p>Tip: Don't bombard people with too many messages at once. (Max: 3)</p>	<p>Step 3: Install the posters to weather and last</p> <ul style="list-style-type: none"> Install in sheltered areas where possible. Install on the inside of glass where possible. Laminate posters if possible for outdoor areas. Install straight and cleanly with strong clear or black tape. <p>Tip: Reduce lamination costs and waste by only laminating posters that could get rained on.</p>	<p>Step 4: Installation best-practice</p> <ul style="list-style-type: none"> Install at eye-level. 1.4m is the optimum height.  <p>Tip: Remove other unimportant posters that distract from Covid-19 messaging.</p>
--	---	--	--

Guide

Recreatable notices

Don't have a printer?

Use this guide to create your own posters. You will need two toilet paper rolls, a pencil, a black marker, paper and a pair of scissors.

Create your shapes:

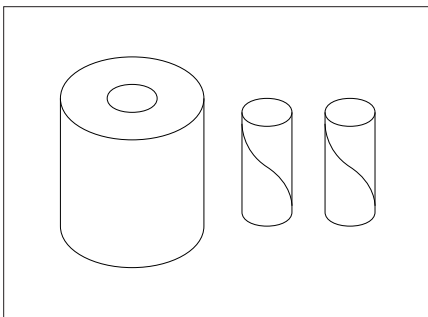

You will need two empty toilet rolls

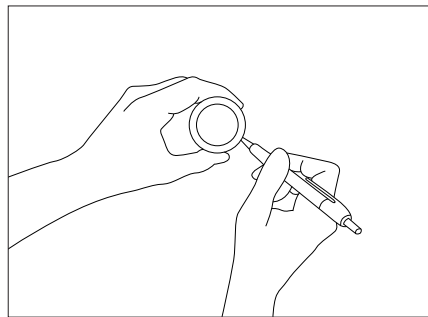

Use one roll to draw circles

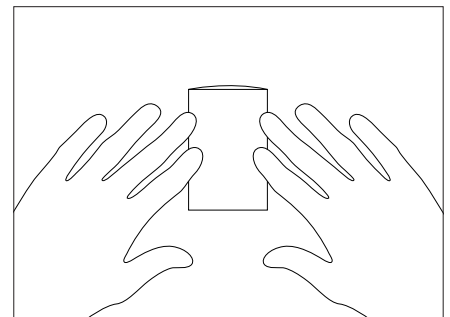

Fold the second roll in half

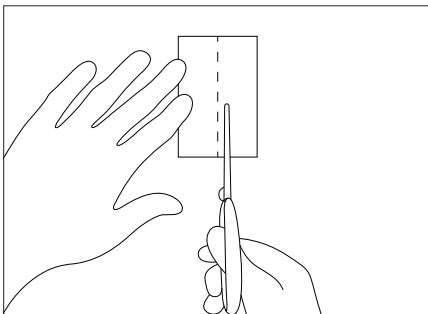

Cut along one of the fold lines

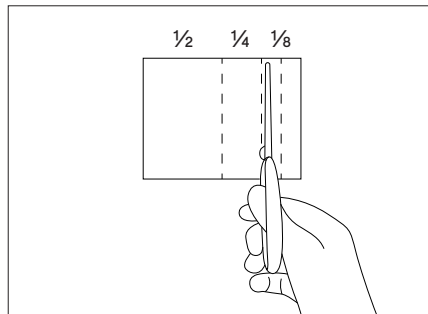

Open and cut into 1/2, 1/4 and two 1/8's

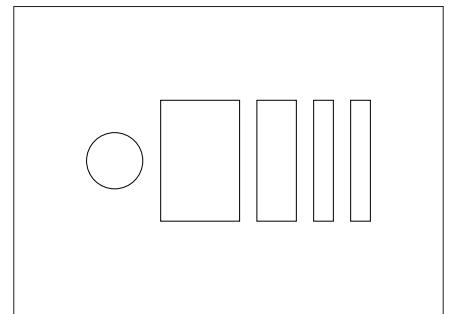

Use these shapes to create pictograms

How to draw your own posters:

1. Outline and combine shapes with pencil.

Leave space for large message

Leave space for small message

2. Fill in the shapes with a black marker.

3. Use the rectangle to align the height of letters.

Don't burst my bubble.

2 metres is further than you think

4. Go over the letters to make letters bolder.

Don't burst my bubble.

2 metres is further than you think

Call us to enter.

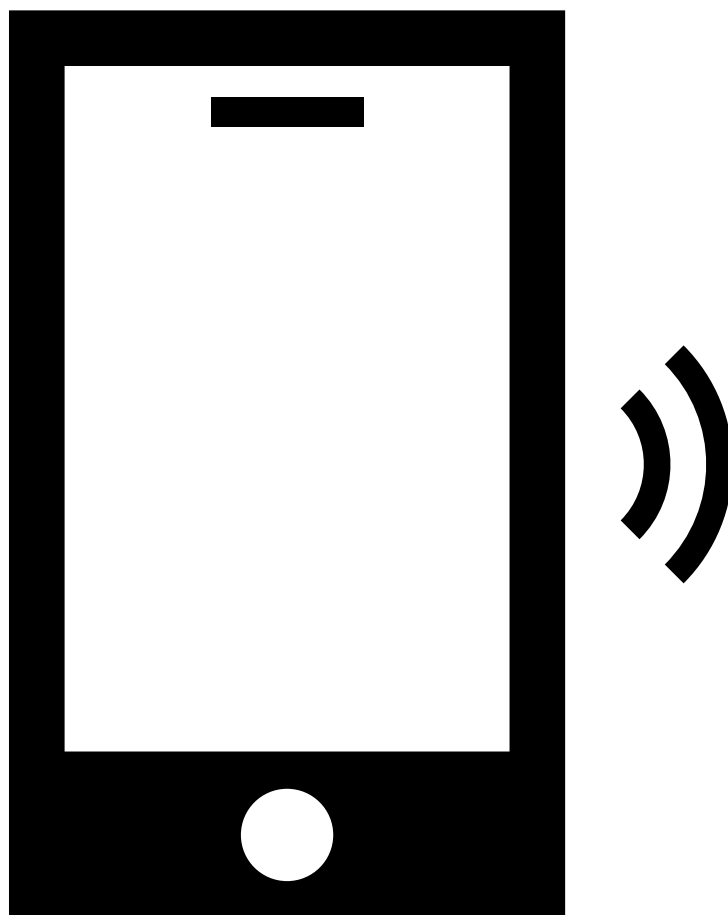

Here's our number.

Don't burst my bubble.

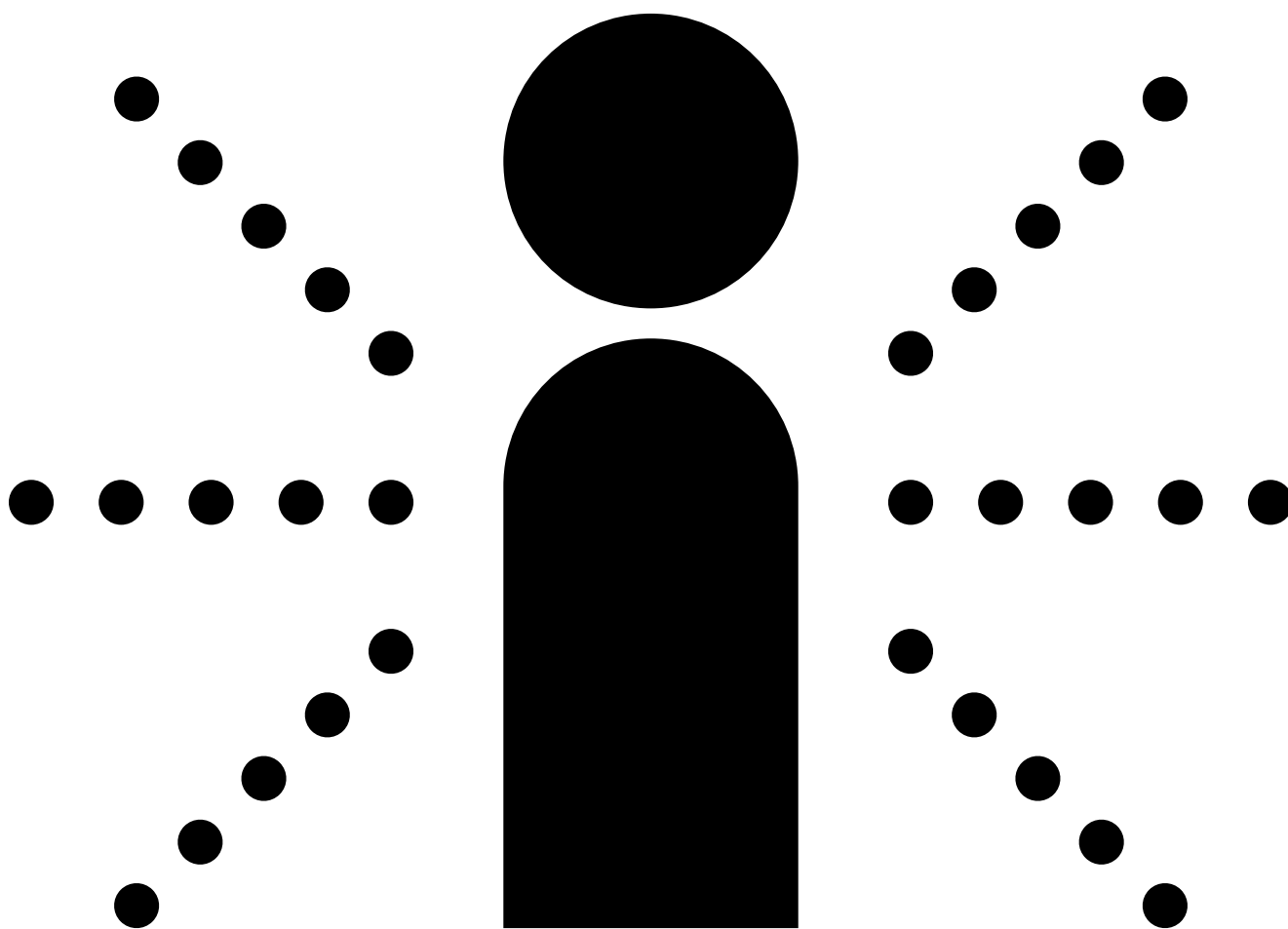

2 metres is further than you think.

Showing symptoms?

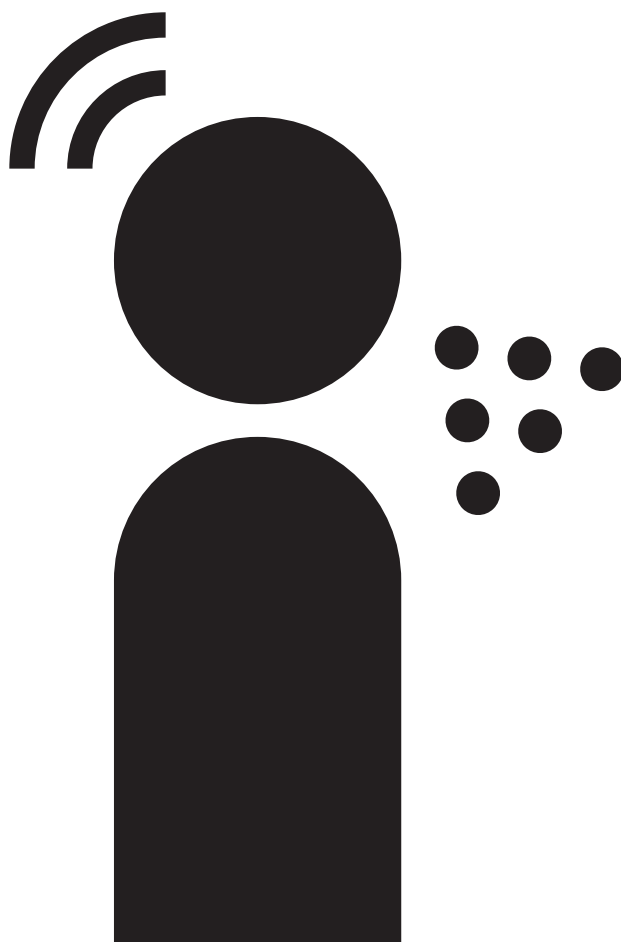

Please give us a call.

Those hands! Wash 'em!

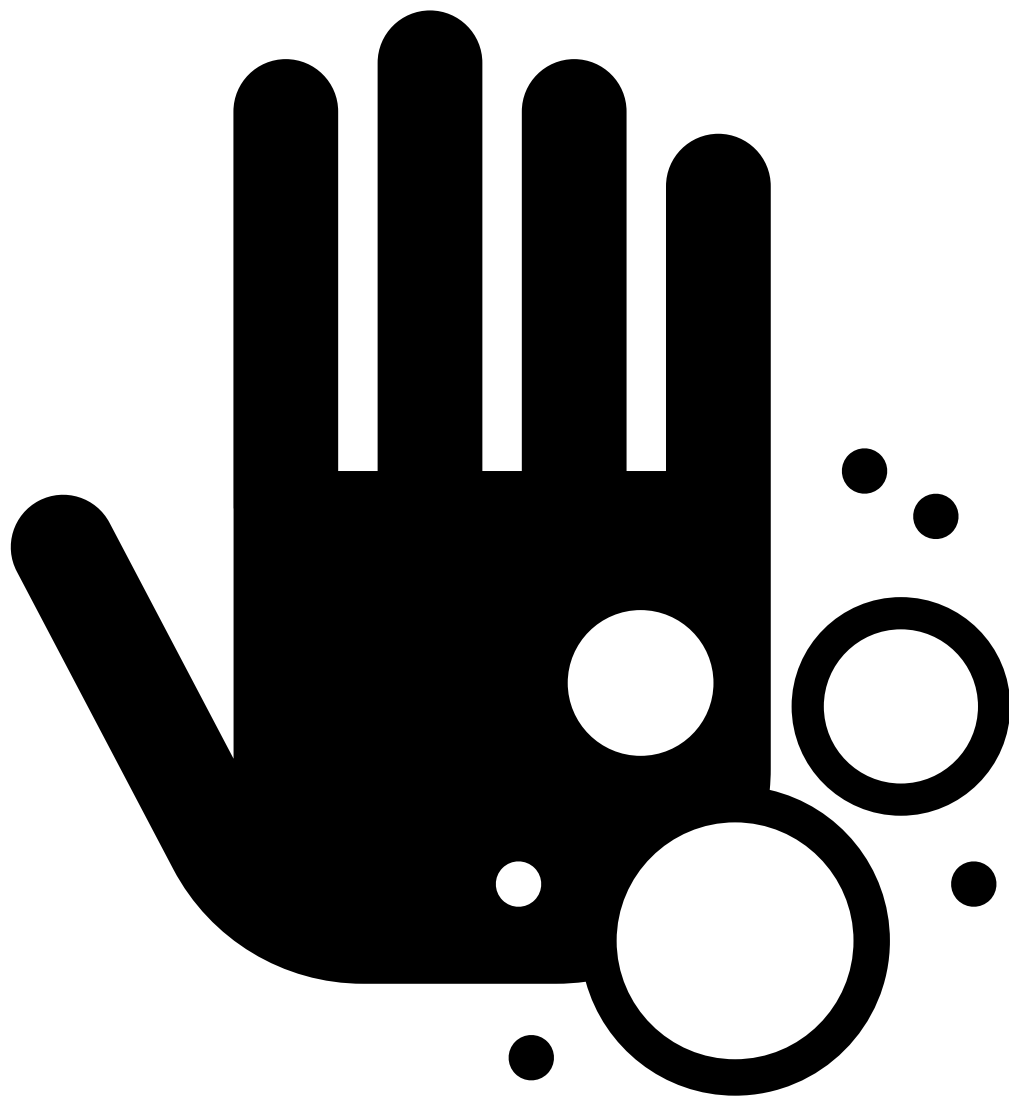

Seriously, set a reminder on your phone.
Maybe clean your phone, too.

Covid-19 Screening

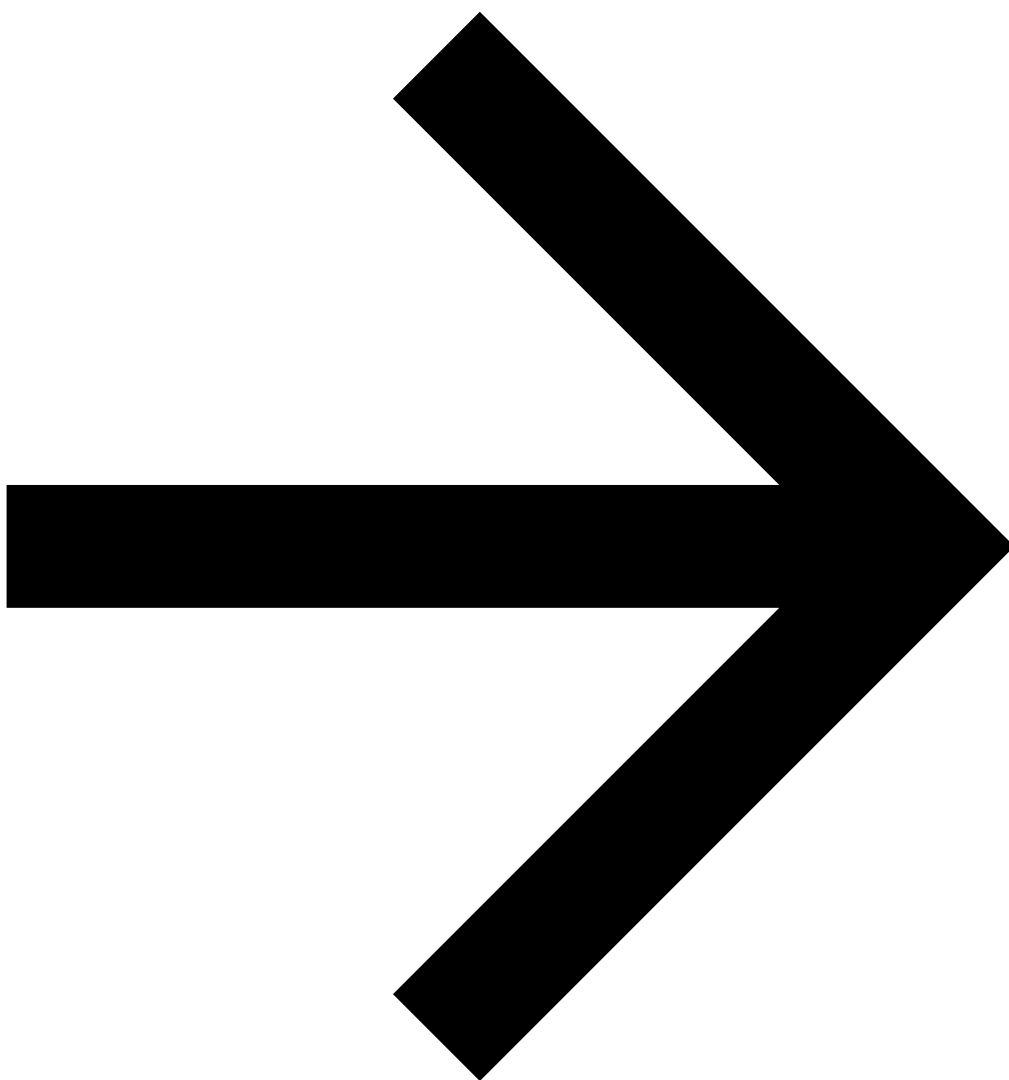

Covid-19 Screening

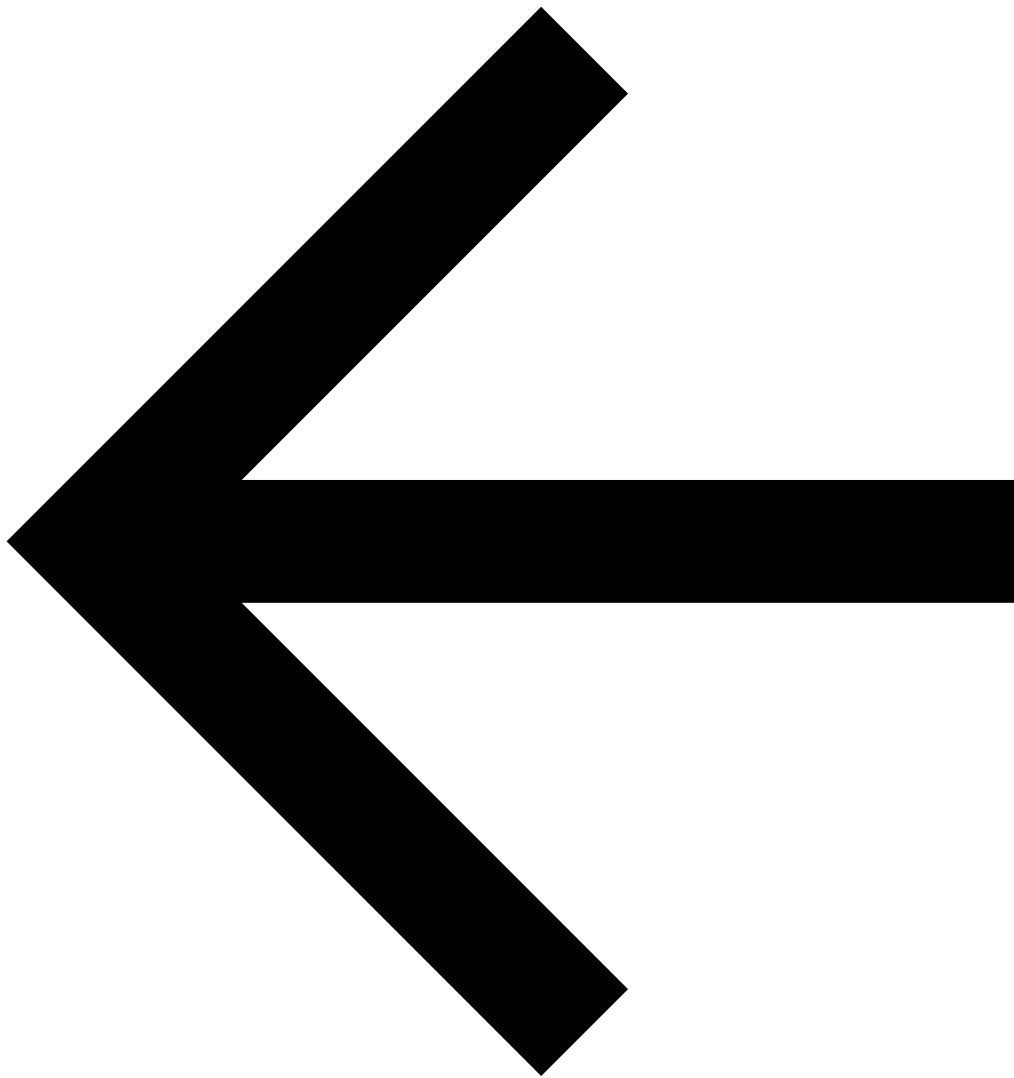

Covid-19 Screening

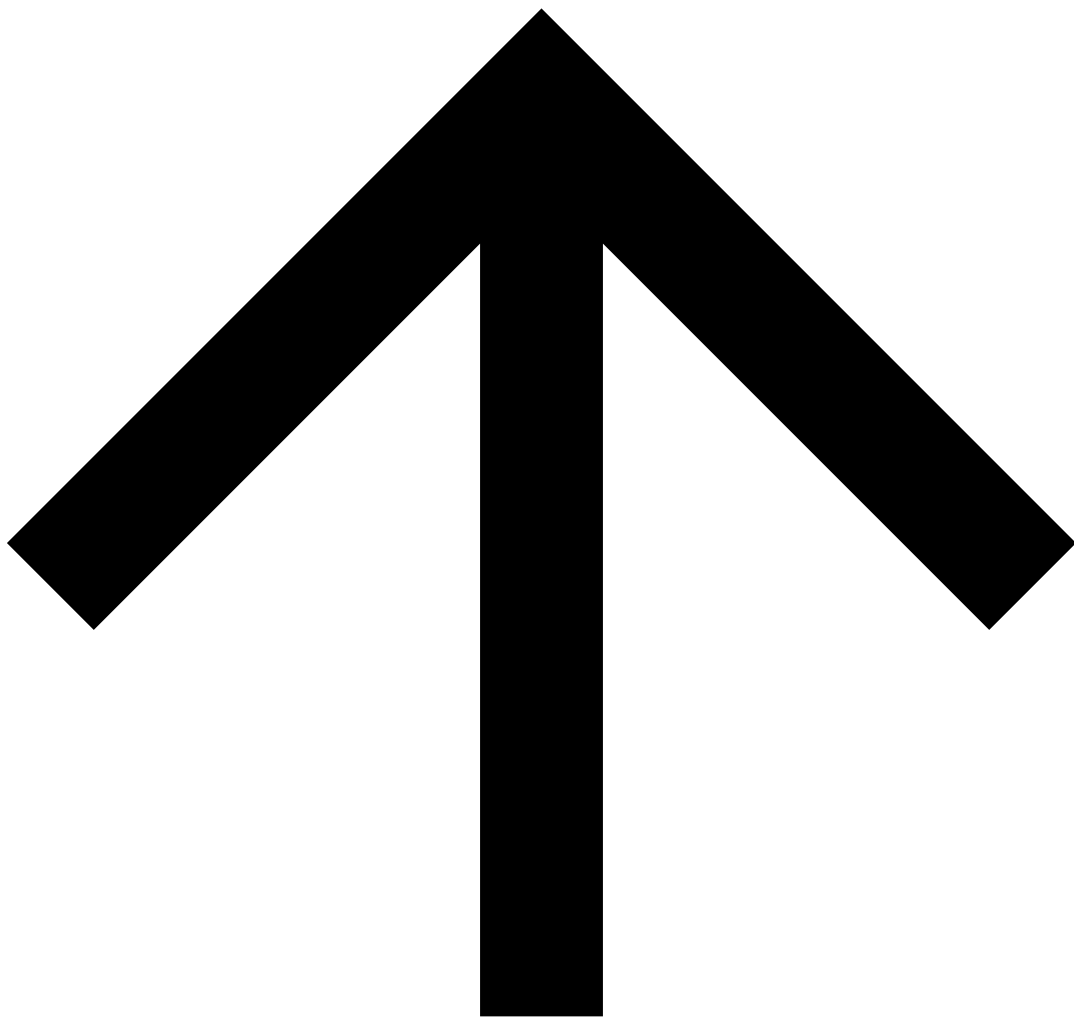

Non-Covid Patients

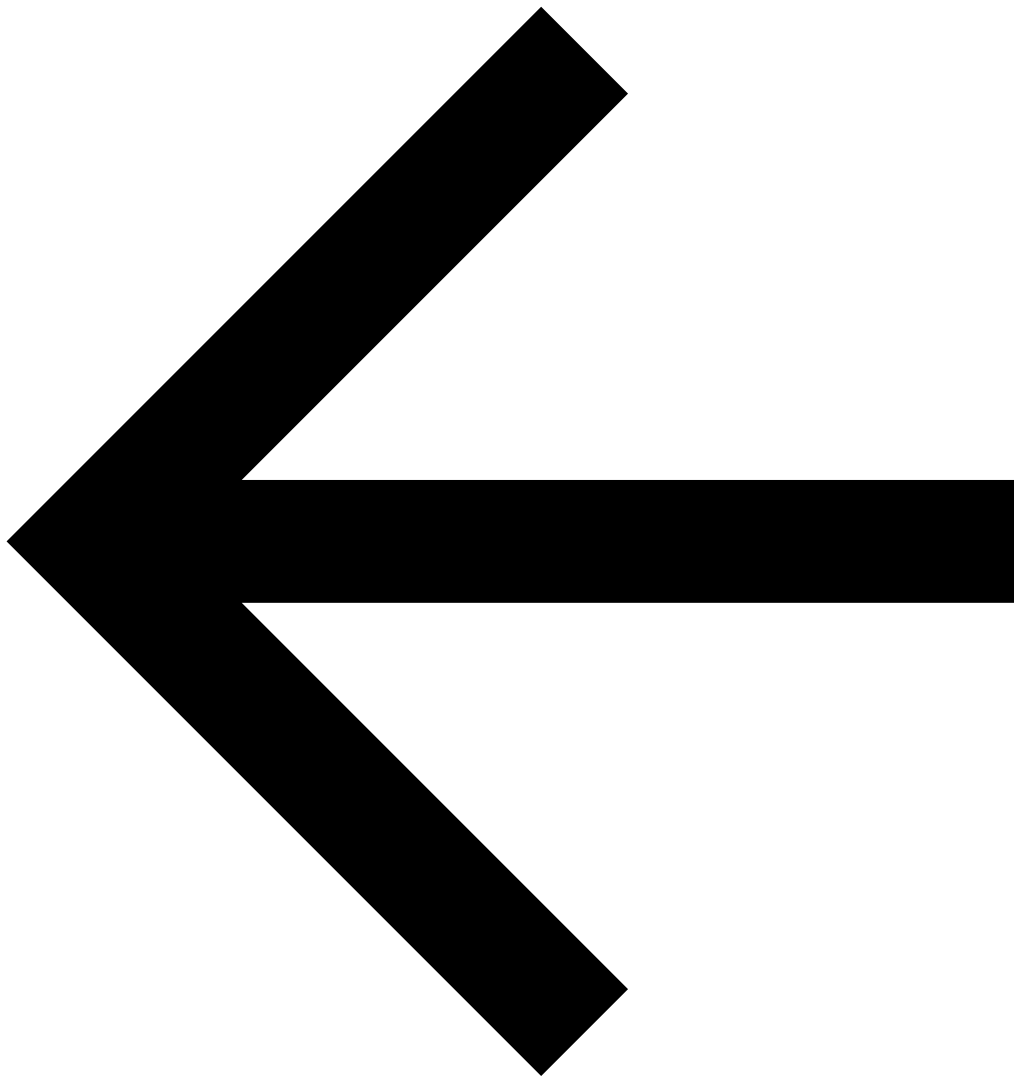

Non-Covid Patients

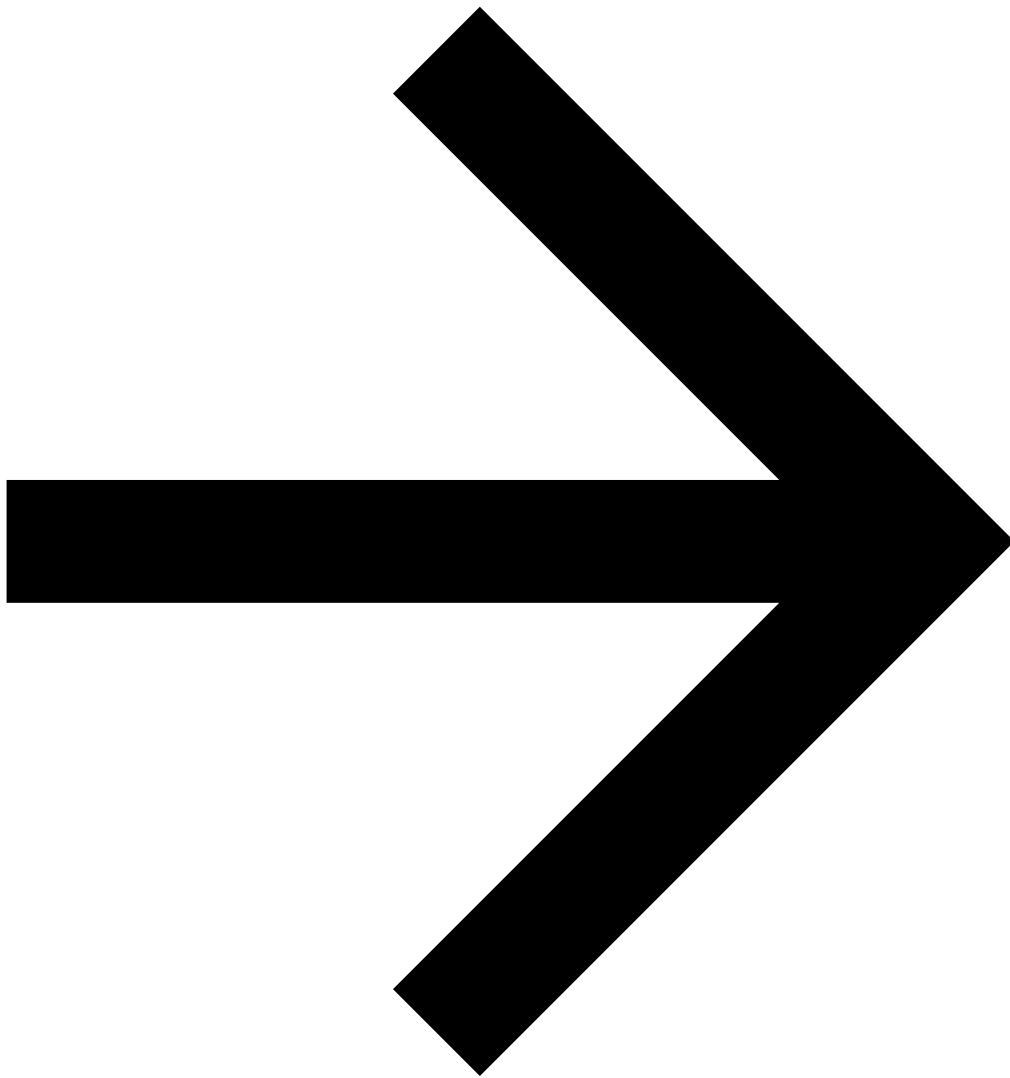

Non-Covid Patients

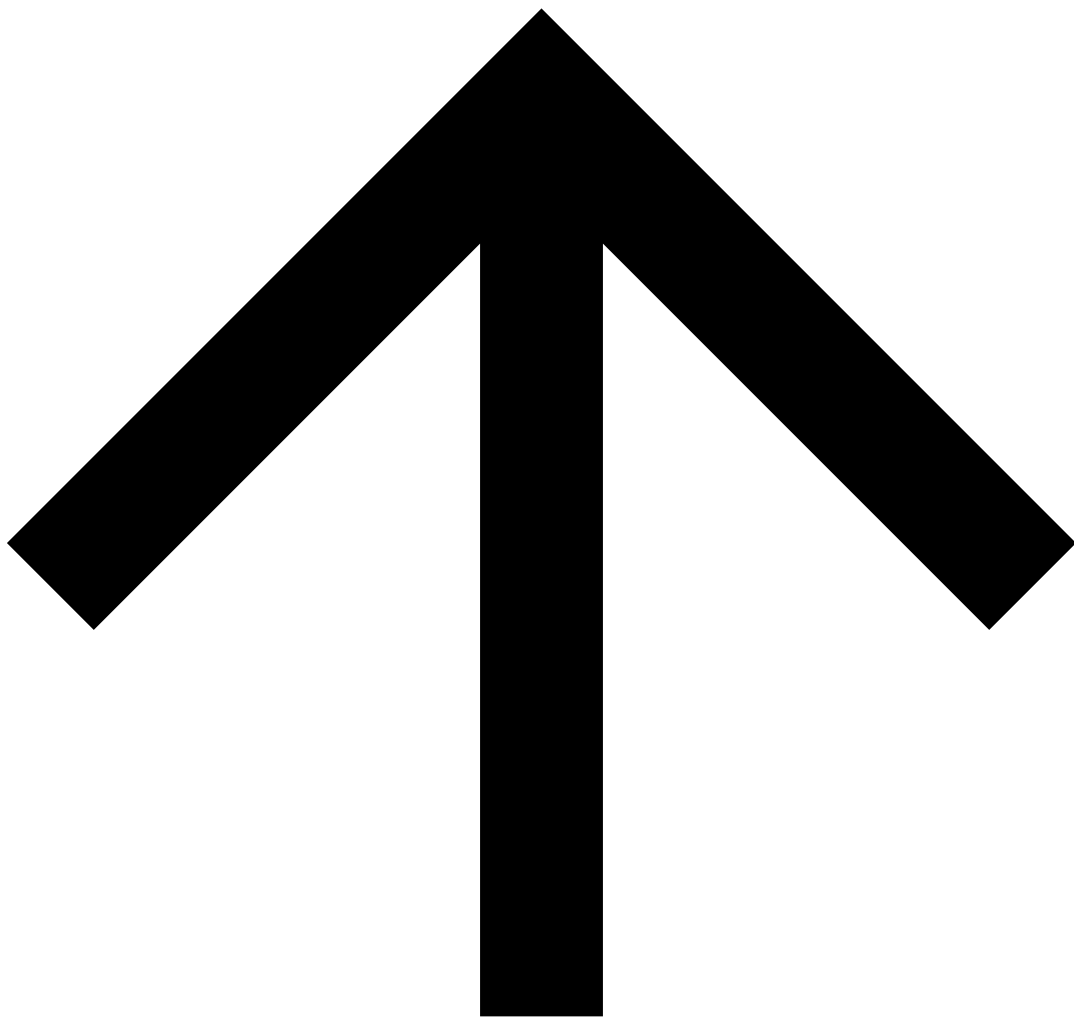

this way

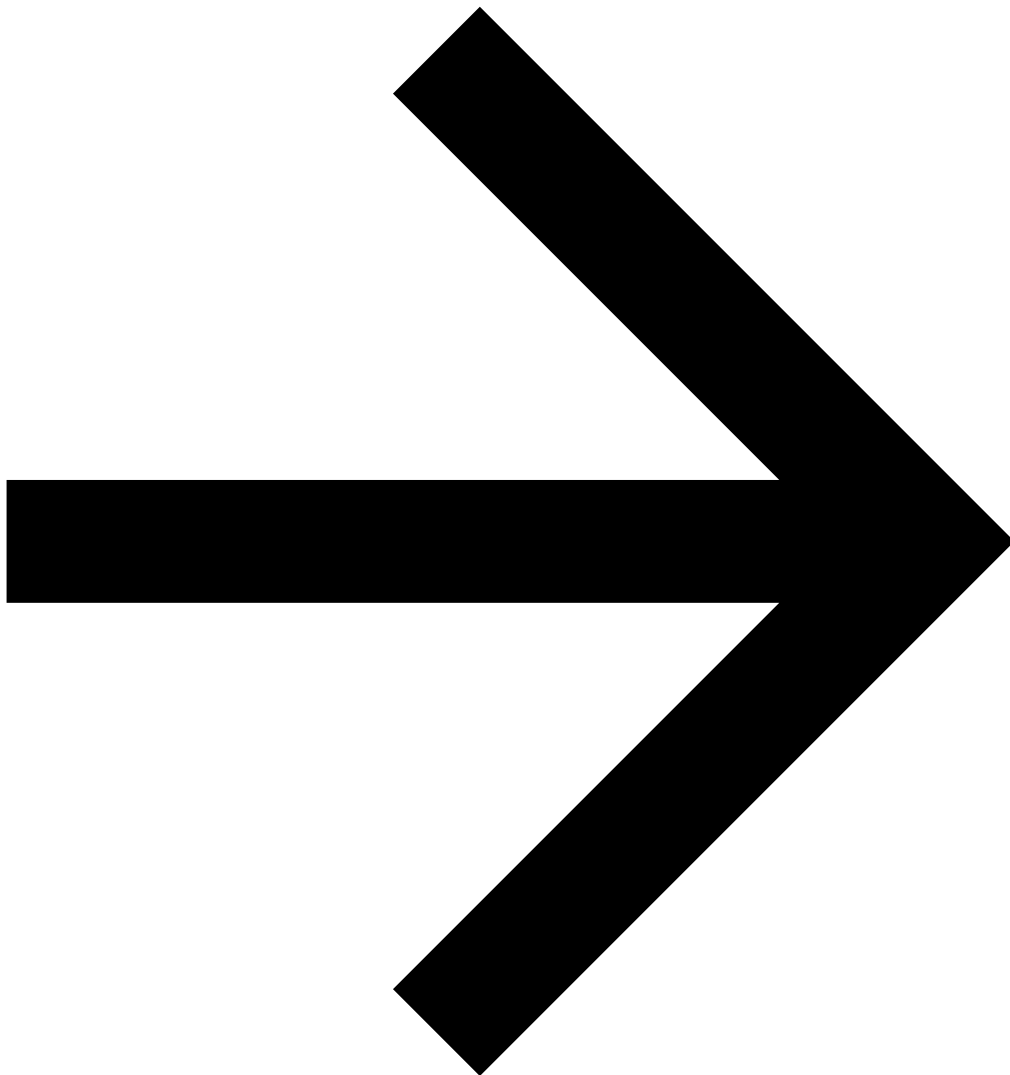

this way

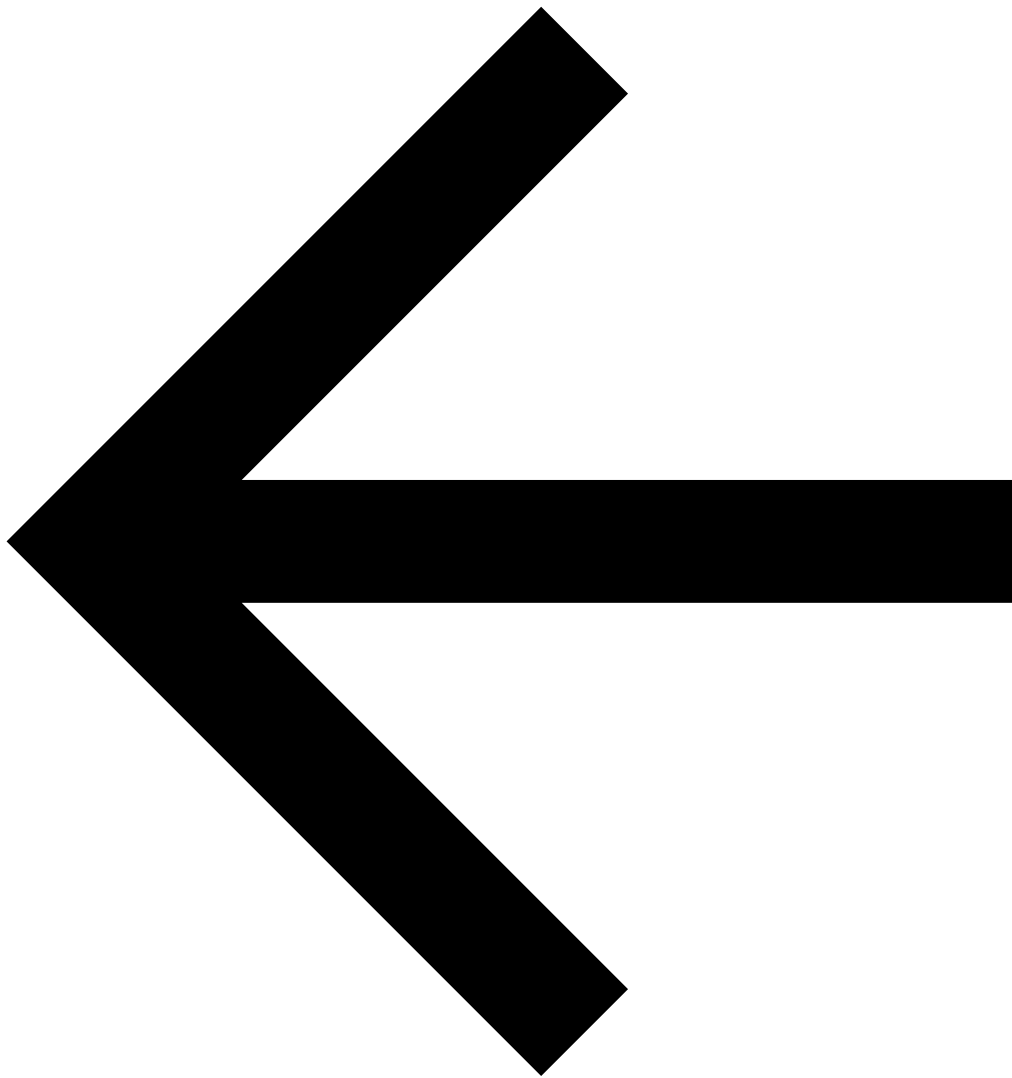

this way

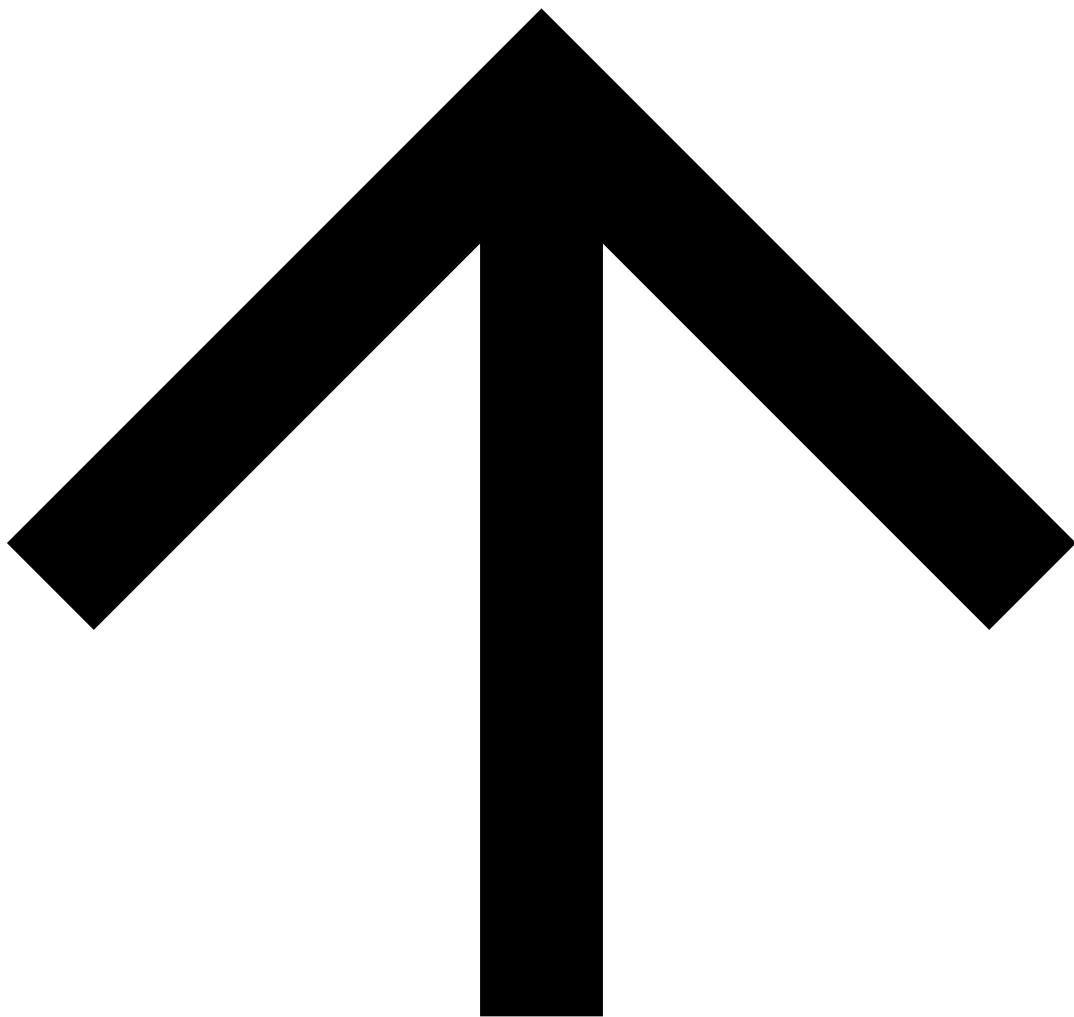

Exit

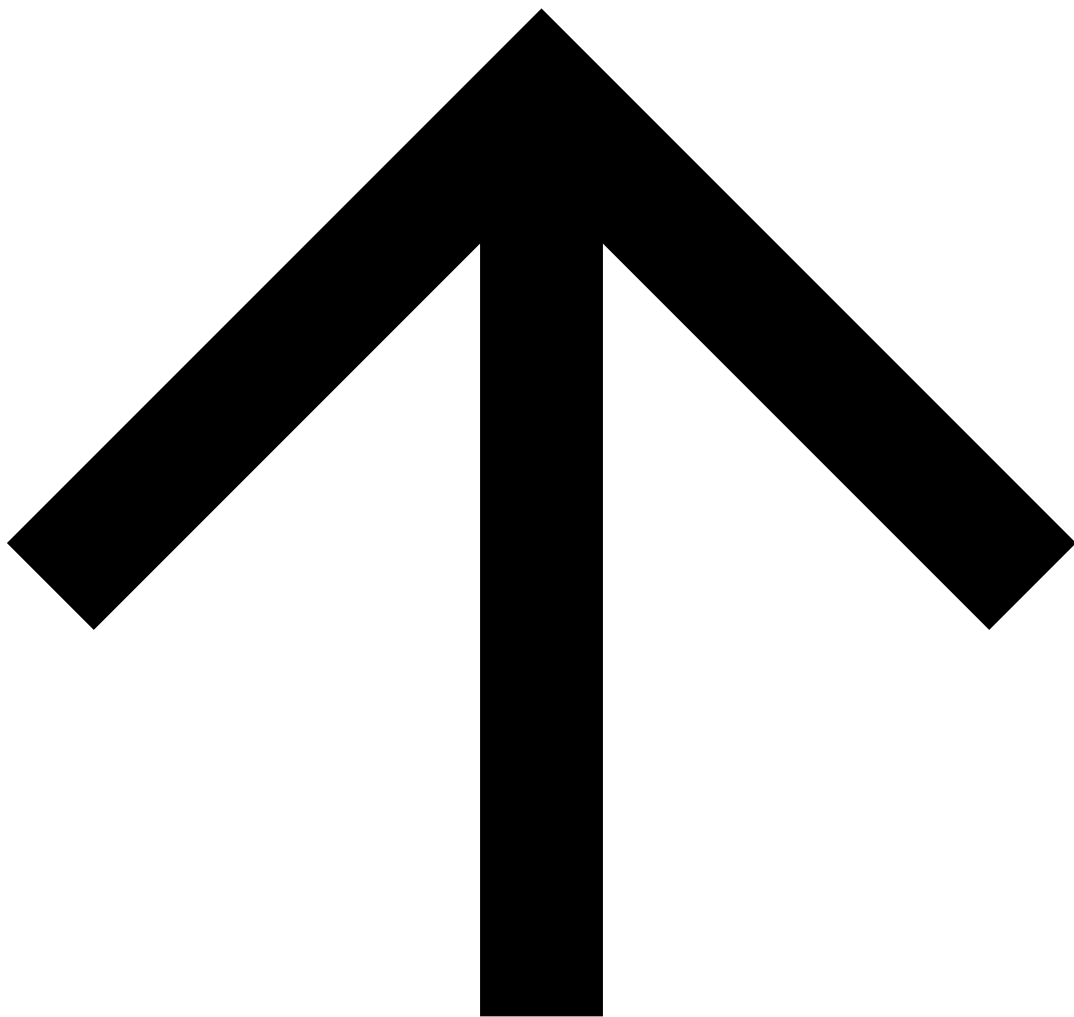

Exit

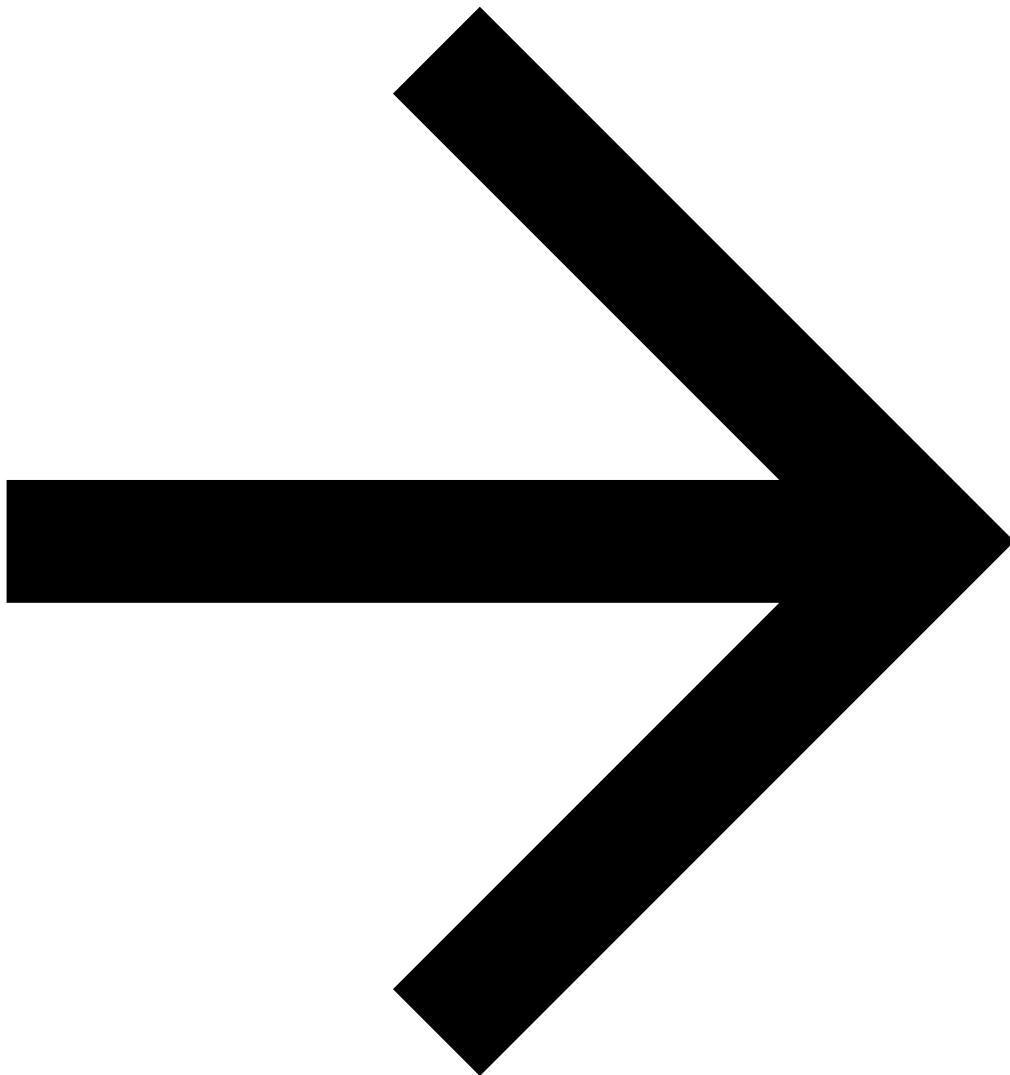

Exit

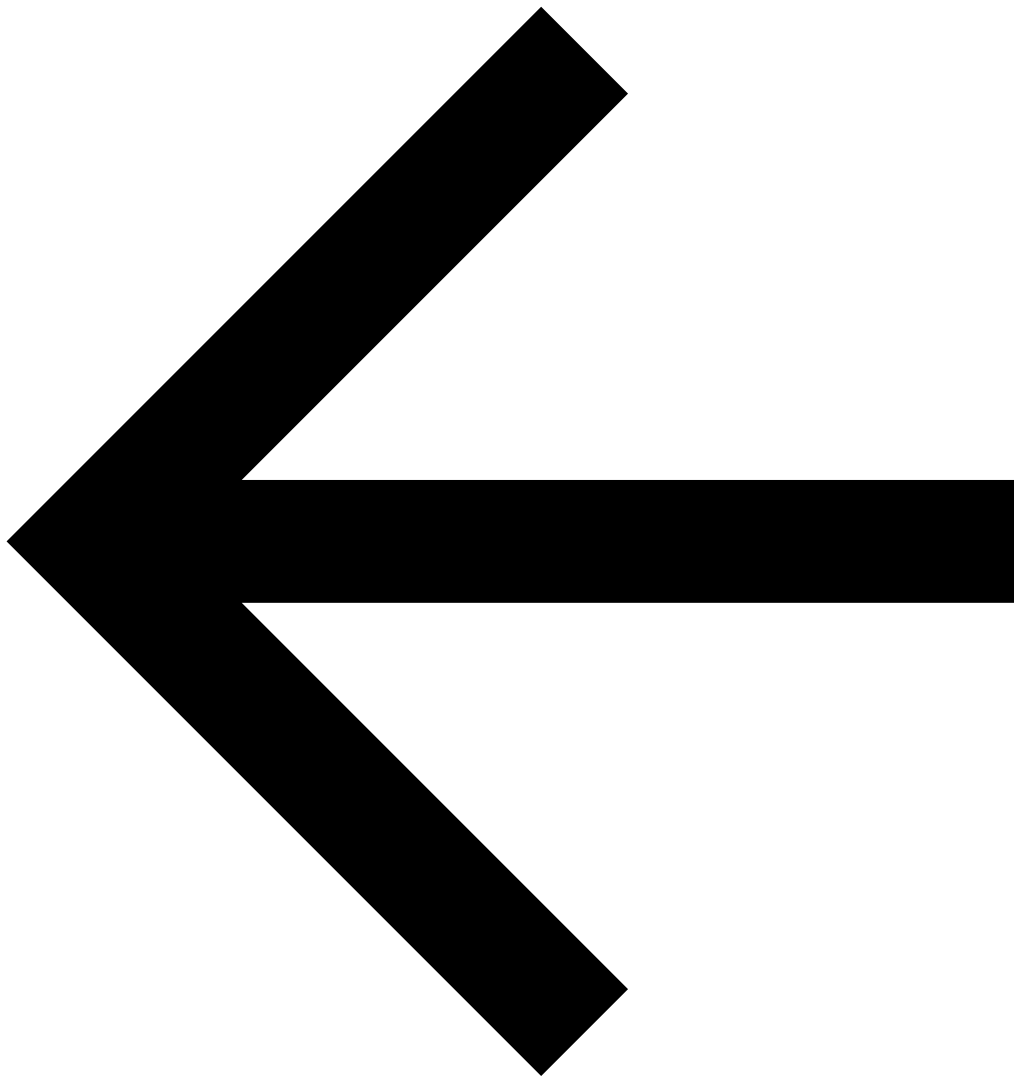

Give it your best shot.

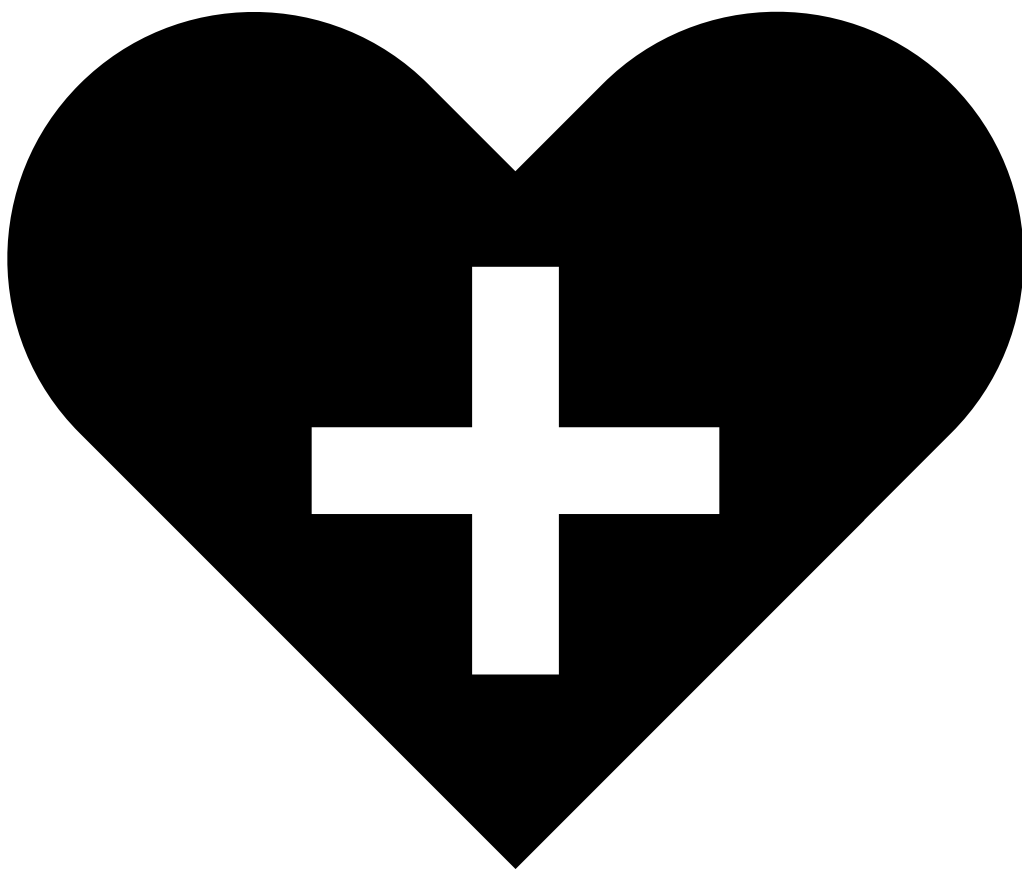

Make sure you get your flu jab.

**Kia kaha.
Kia māia.**

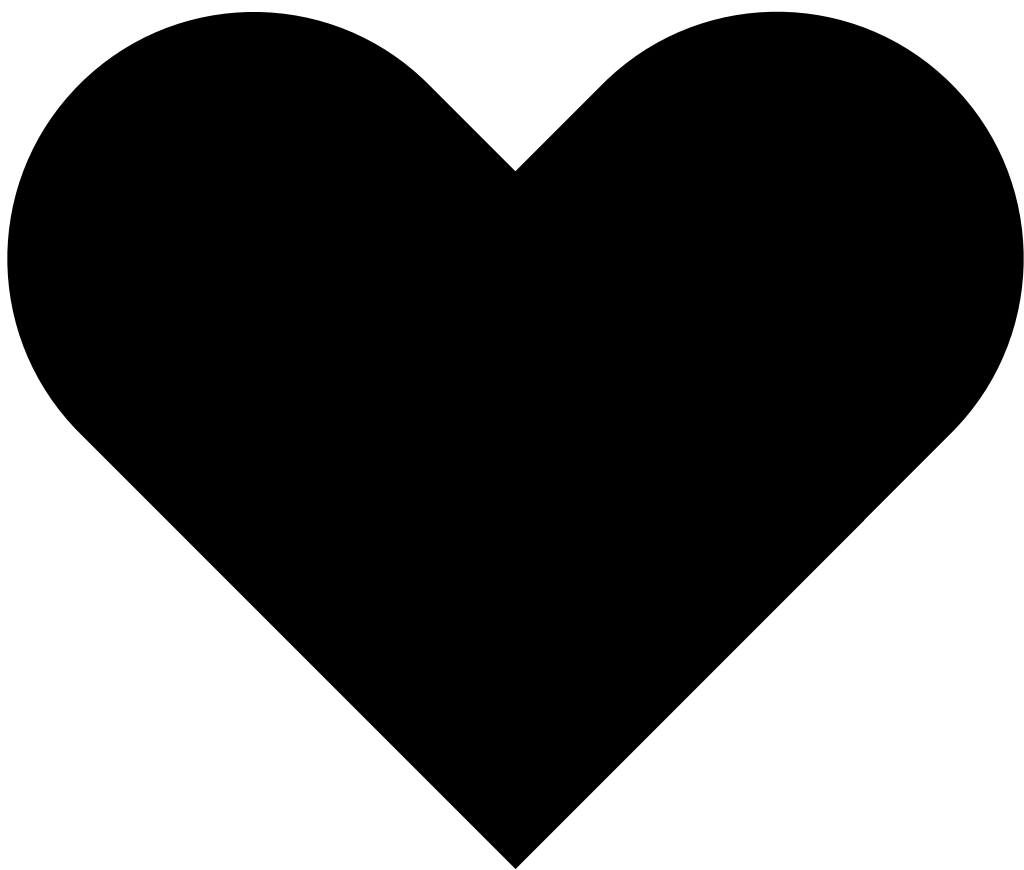

Be strong. Be brave. Be kind.
And please reach out if you need help.

**Be brave.
Be kind.**

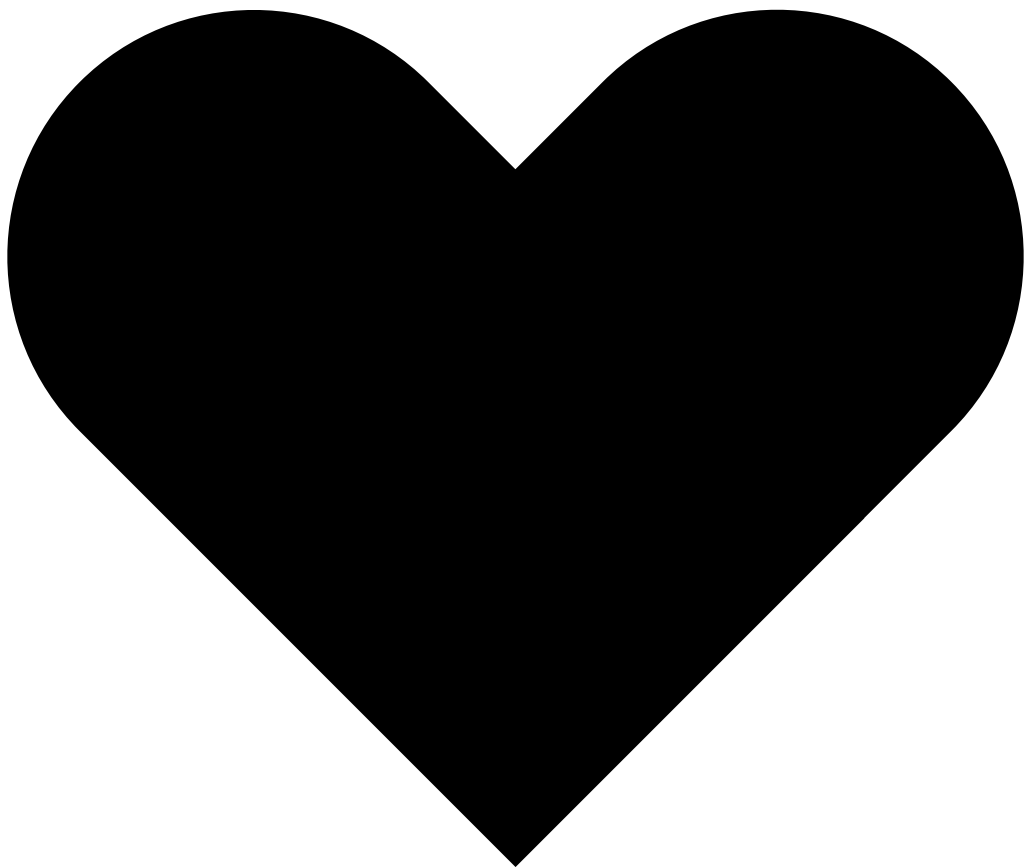

And please reach out if you need help.

Hand sanitiser

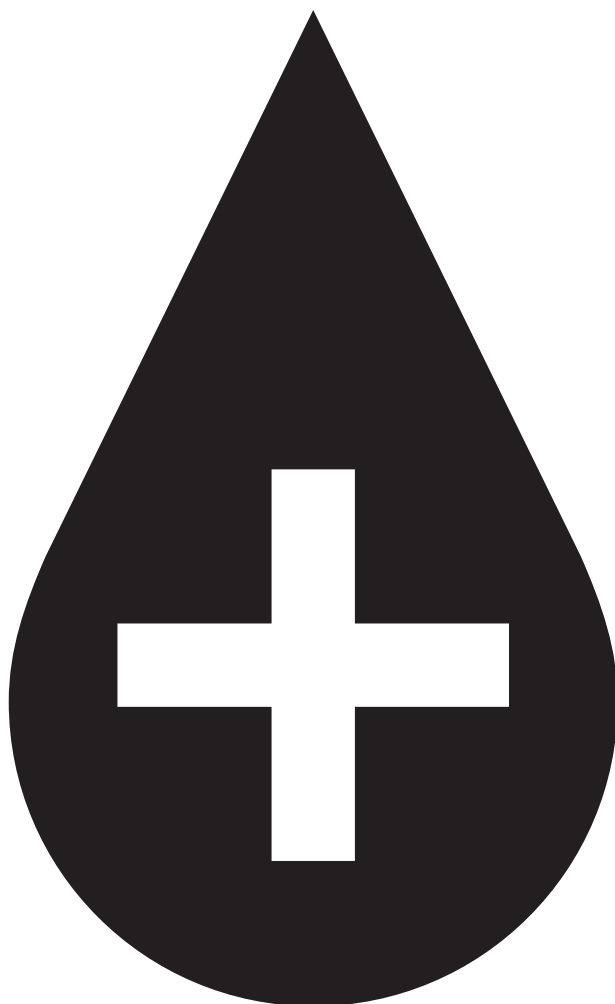

Everyone must sanitise their hands
before entering. Thank you!